

Product Information



A. u. K. Müller

Solenoid valves
Control valves
Special valves and systems

A. u. K. Müller GmbH & Co. KG
Dresdener Str. 162
D-40595 Düsseldorf/Germany

Tel.: +49(0)211-7391-0
Fax: +49(0)211-7391-281

e-mail: info@akmueller.de
Internet: www.akmueller.de

Series 50.007.800



Characteristics

- servo-controlled
- long term performance capability
- internal double pollution protection
- compact design
- optimized water hammer characteristic by low noise emission according to EN 60730 in plug in contour
- easy to assemble and service
- low power consumption
- any fitting position
- high operating safety by the use of high quality materials and 100% final testing of the products

Applications

- sanitary fittings
- irrigation systems
- industrial appliances
- pilot system for valves with a larger nominal diameter

Description

2/2-way bistable servo controlled solenoid valve, DN 7, in cartridge design. Especially developed to control potable water in battery driven, opto electronically operated faucets.

Power consumption is minimised by use of rectangular pulse control to increase long term performance, durability and battery life.

Compact design makes it easy to integrate the valve into sanitary faucets and the plug-in design simplifies installation and service.

typical performance curve (determined plug-in contour)

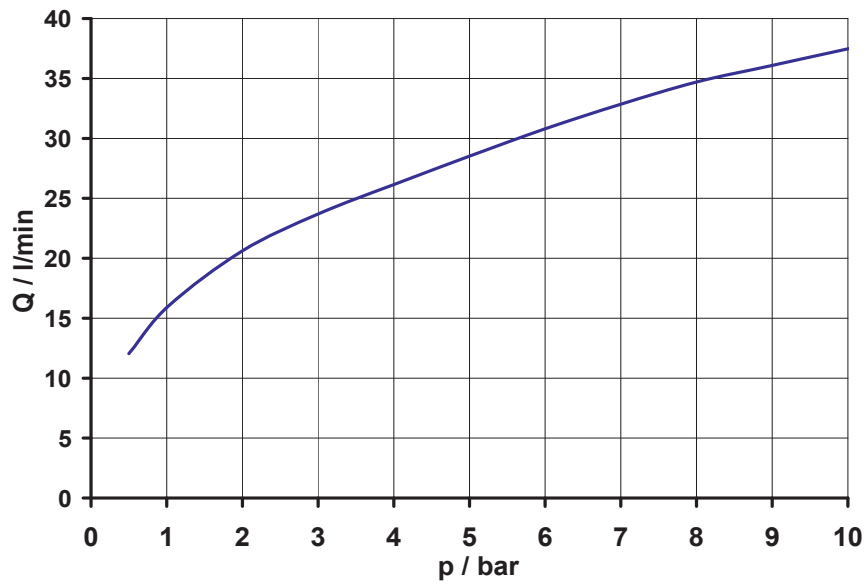



Series 50.007.800

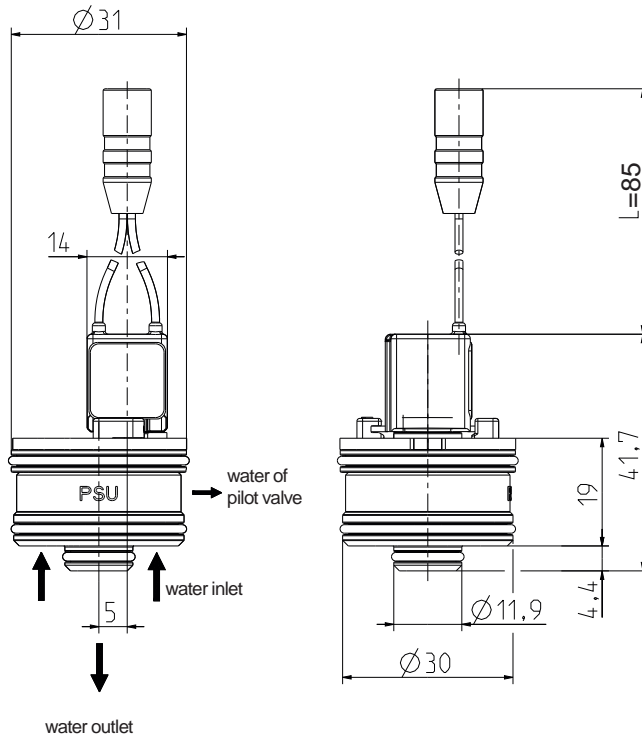

Technical Data

| | | |
|--------------------------|---|--------------------------|
| Type | 2/2-way acentric cartridge valve, bistable | |
| Construction | plug-in, servo controlled | |
| Function | bi stable, pulse controlled | |
| Fitting position | any | |
| Media | cold and heated potable water and physically and chemically similar media | |
| T-Medium | 5 - 70 | °C. |
| T-Ambient | 5 - 50 | °C |
| DN | 7 | mm |
| p-Operating | 0,5 - 10,0 | bar |
| Cv-value | 16 | l/min |
| pressure surge | according to EN 60730 | |
| Nominal voltage | 6 (9 | V DC V DC on request) |
| | special voltage on request | |
| Operating voltage | 4,75 - 7,5 V DC open/close at T-Ambient 25 °C | |
| Pulse shape/-time | | |
| | | |
| Nominal power | 1,4 W | at nominal voltage |
| Protection Type | IP 65 | |
| Insulation class | A | according to EN 60730 |
| Protection class | III | according to EN 60730 |

Materials

| | |
|------------------------------|-----------------|
| Valve body | PSU |
| Plunger guide | POM |
| Plunger and spring | stainless steel |
| Membrane and sealings | EPDM |
| Coil coating | hotmelt |

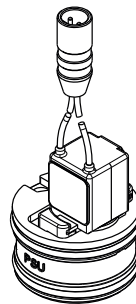

Options

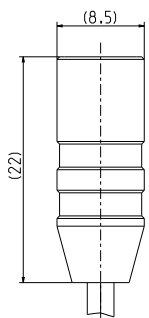

Male connector

Polarity of connector:
strand color **RED** Pin 1
strand color **BLACK**

PLUS(+) pulse to open
MINUS(-)

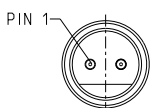

Product Information

Acentric cartridge valve, bistable



A. u. K. Müller

Series 50.007.800

Plug in contour

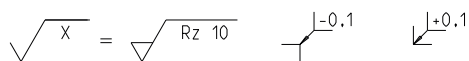
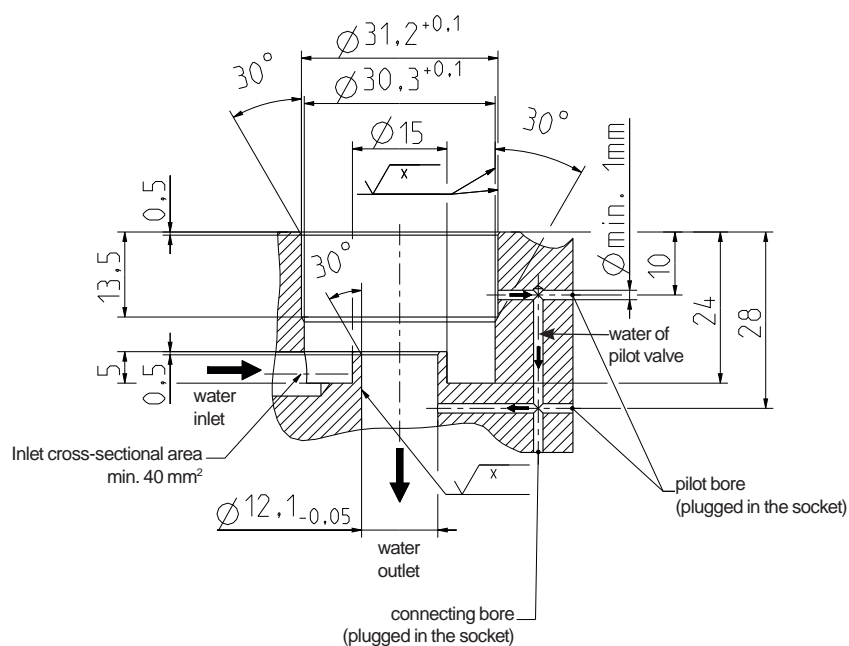

Valve securement

